

# Owner's Manual

Instruction  
Book for:

MODEL 870 &  
870 SUPER MAGNUM  
PUMP ACTION SHOTGUNS

*Remington*®

**IMPORTANT!**

READ ALL INSTRUCTIONS  
AND WARNINGS IN THIS  
BOOK BEFORE USING THE FIREARM.



PAGE 2.....THE TEN COMMANDMENTS OF  
FIREARM SAFETY

PAGE 7.....IMPORTANT PARTS OF THE FIREARM

PAGE 10.....HOW TO LOAD AND UNLOAD

PAGE 13.....LUBRICATION AND MAINTENANCE

PAGE 15.....HOW TO OBTAIN PARTS AND SERVICE

# A Tradition of Performance and Safety.

In 1816 Eliphalet Remington was confident he could make a flintlock that was as good or better than any he could buy. His confidence was well founded. The barrel he handcrafted set a new standard for firearm accuracy and spawned generations of products that have made Remington® Arms America's leading gunmaker. While performance and style are certainly hallmarks of Remington firearms, one factor ultimately drives their performance. Safety. Eliphalet Remington never lost sight of the fact that his rifles were potentially lethal and could kill someone if handled improperly. And after more than 180 years the same holds true for any firearm, including your new Remington. Eliphalet Remington's first flintlock launched a proud tradition of accuracy and responsibility.



*Eliphalet Remington's first flintlock launched a proud tradition of accuracy & responsibility.*

## Safety is Critical to Performance.

A superbly crafted gun is only as good as the hands that hold it. You can never be too careful. Shooting accidents are often caused by careless oversights such as failing to control the direction of the muzzle, failing to fully engage the safety, leaving ammunition in the chamber or using improper loads. These oversights can result in the destruction of life, limb or property. There's no calling back a bullet once it's been fired, so it's critical that you know the principles of safe gun handling and storage before you ever take your new Remington firearm out of the box.

The proper use and performance of your firearm depends on correct assembly and maintenance, so it's critical that you familiarize yourself with the information in this instruction book. Even if you're a veteran shooter with a collection of Remington firearms, take the time to read this literature. Not all firearms are the same. That means the first step in safe handling is to learn the features and requirements of your new Remington.

### THE TEN COMMANDMENTS OF FIREARM SAFETY

The Ten Commandments of Firearm Safety should be etched in your memory forever. Let them govern your action wherever and whenever you're involved with firearms. In the field. On the range. Or in your home. Please take the time to review and understand these rules.

#### 1st COMMANDMENT

### Always Keep the Muzzle Pointed in a Safe Direction.

*This is the most important gun safety rule.* A safe direction is one in which an accidental discharge will not cause injury to yourself or others. Never allow your gun to point at anything you don't intend to shoot. Be especially careful when you're loading or unloading. Treat every gun as if it were loaded. And make it a habit to know where the muzzle is pointed at all times, even when your firearm is unloaded. No one will be injured by an accidental discharge if you keep your firearm pointed in a safe direction. It's as simple as that.



#### 2nd COMMANDMENT

### Firearms Should be Unloaded When Not Actually in Use.

*Load your firearm only* when you're in the field or on the target range and ready to fire. Never let a loaded gun out of your sight or out of your hands. Unload it as soon as you're finished shooting – before you bring it into your car, camp or home. Remember, unloading your firearm means unloading it completely, so there is no ammunition in the chamber or in the magazine. Before handling a firearm or passing it to someone else, visually check the chamber, receiver and magazine to be certain they do not contain ammunition. Always keep the gun's action open when not in use. Never assume a gun is unloaded even if you were the last person to use it. Always check for yourself.

*Let common sense rule* when you carry a loaded gun. If you're in a situation that could risk accidental discharge – such as crossing a fence, wading through a stream or climbing a tree – always unload your gun. Never pull or push a loaded firearm toward yourself or another person. And never carry a loaded gun in a scabbard, detached holster or gun case.

*Certain firearms* (including some Remington® rifles and shotguns) are equipped with internal security devices to prevent unauthorized use. In addition, some firearms owners use external devices, such as cable locks and trigger blocks, for the same purpose. Even if you use such a device, you should still keep your firearm unloaded when stored or not in use. And using internal or external devices cannot substitute, however, for securing your firearms and ammunition in a separate, locked location.

*Safe storage of firearms* is just as critical as safe handling. Never store guns loaded and be sure to keep your firearms in a secure place where unauthorized persons cannot get their hands on them without your knowledge.

*Take special care* if there are children around. Kids are fascinated by guns. It's a natural curiosity that can have tragic consequences when not properly supervised. Store your firearms in a locked gun safe or some other location that physically bars a child from gaining access.

*Ammunition should be stored* and locked in a location separate from your firearm. Never leave an unsecured firearm or ammunition in a closet, dresser drawer or under the bed. Remember, it is your responsibility to make sure that children and others unfamiliar with firearms cannot gain access to your firearm and ammunition.



*Firearms should be stored in a secure place where children cannot access them. A gun safe is an ideal way to secure your firearm.*

### 3rd COMMANDMENT

#### **Don't Rely on Your Gun's Safety.**

*Treat every gun* as if it can fire at any time, whether or not there's pressure on the trigger. Your firearm has been carefully designed to maximize performance and safety. However, because a gun's safety is a mechanical device that could fail.

*Human error* is a more likely reason for a gun safety to fail. By mistake, you may think the safety is on when it really isn't. Or the safety may have been disengaged without your knowledge. Or you could think your gun is unloaded when there's actually a cartridge or shell in it. A mechanical safety is not a substitute for common sense. It's merely a supplement to your proper handling of a firearm.

*Never touch the trigger* on a firearm until you are ready to shoot. Keep your fingers away from the trigger when you're loading or unloading. And don't pull the trigger when the safety is engaged or positioned between safe and fire.

*Before using your gun*, read this instruction book to understand the exact location and operation of your firearm's safety. Even when the safety is on, maintain control of your loaded firearm and control the direction of the muzzle. In other words, don't rely on your safety to justify careless handling. If your firearm's internal mechanisms are broken or have been altered, your firearm may fire even when the safety is on. Remember, you and your safe gun-handling practices are your gun's best safety.

### 4th COMMANDMENT

#### **Be Sure of Your Target and What's Beyond It.**

*You can't stop a shot in mid-air*, so never fire unless you know exactly where your shot is going and what it will strike. Never fire at a sound, a movement or a patch of color. A hunter in camouflage can easily be mistaken for a target by an impulsive shooter. Before you pull the trigger be absolutely sure of your target and what's behind it. Make sure

the shot has a backstop such as a hillside or dense material like sand. Remember, bullets can travel great distances with tremendous velocity. Know how far your shot will go if you miss your target or the bullet ricochets.

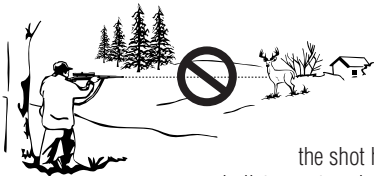

## **Use Proper Ammunition.**

*Every firearm is designed* to use a certain caliber or gauge of ammunition. Using the wrong ammunition, mixing ammunition or using improperly reloaded ammunition can cause serious personal injury or death. And it only takes one cartridge or shotshell of the incorrect caliber or gauge, or which has been improperly reloaded, to destroy your firearm. It's your responsibility to make sure the ammunition you use exactly matches the caliber or gauge of your gun. Refer to this instruction book to find out the specific requirements of your firearm. Always read and heed the instructions on ammunition boxes.

*Confusing shells* or cartridges can cause serious personal injury or death and destroy your firearm. Examine your shells or cartridges closely and use only the precise caliber or gauge for your specific firearm. For example, suppose you accidentally loaded a 20 ga. shell into a 12 ga. shotgun. Because the 20 ga. shell is too small for the chamber, the 20 ga. shell could travel down the barrel and get lodged in the bore. If you then loaded a standard 12 ga. shell behind it and fired, the 12 ga. shot will slam into the lodged 20 ga. shell and may cause the barrel to explode in your hand. This is commonly called a 12/20 burst, and it can kill you.

*Check all ammunition* before you load it to make sure it matches your gun's requirements. Every Remington® cartridge and shell is head-stamped with its caliber or gauge for easy identification. Likewise, you'll find the caliber or gauge of your new Remington firearm imprinted on the barrel.

## **Reloading Requires Extra Diligence.**

*If you're an ammunition reloader*, you are responsible for personally assuring that the loads and components of your reloaded ammunition meet your gun's factory-tested standards. Never use ammunition which has been reloaded by someone else!

*Many shooters handload* as a hobby or to save money on commercial, factory-made ammunition. However, it requires a thorough knowledge of reloading procedures and a deep respect for the explosive potential of gunpowder.

*Firearms are designed*, manufactured and proof-tested to standards based on factory-loaded ammunition. Handloaded or reloaded ammunition that deviates, either intentionally or accidentally, from load or component recommendations can be very dangerous.

*Reloaders must observe* all possible safety precautions and practices related to the proper handling of explosives. Whether you're a seasoned reloader or just starting out, you should study the subject, watch reloading demonstrations and talk to experienced reloaders.

*The first rule of reloading* is to always follow the manufacturer's instructions for the components you're using. They'll tell you to follow certain guidelines. Namely:

1. Don't mix or substitute powders or primers.
2. Don't use unknown or substandard components.
3. Use only suitable components that have been factory-tested by reputable ammunition, powder and bullet manufacturers.
4. Always be sure to use the manufacturer's recommended recipe when reloading.

*Not following these guidelines* could result in severe injury to yourself or severe damage to your firearm. Dangerously high pressure and explosions can result from an overcharge of powder or other deviations from established reloading guidelines. Be very careful. The process of reloading exposes you to environmentally hazardous material. Lead, which is known to cause cancer and birth defects, is the most common substance in bullets and shot. It is important to handle lead bullets and shot with extreme care. Work only in a well-ventilated area and always wash your hands after exposure and before eating. Never smoke while reloading.

*Primers and powders* are also highly toxic and flammable. So after reloading be sure to clean up all materials from your work area. Don't leave primer or powder spills anywhere on the floor or bench top. Dispose of all waste material in accordance with the manufacturer's recommendations.

*Finally, when reloading* or handloading concentrate on what you're doing at all times. Do not be distracted by talking to others, listening to the radio or watching TV while reloading. Never reload after consuming alcoholic beverages or drugs of any kind. You are working with extremely hazardous materials and you can't risk even a few seconds of distraction. Remember, if you reload, you are the ammunition manufacturer and you are responsible for the performance and safety of your reloaded ammunition.

## 6th COMMANDMENT

### **If Your Gun Fails to Fire When the Trigger is Pulled, Handle With Care.**

*If for some reason* the ammunition doesn't fire when you pull the trigger, stop and remember the 1st Commandment of Firearm Safety – always keep the muzzle pointed in a safe direction. Keep your face away from the breech, then put the safety on, carefully open the action, unload the firearm and dispose of the cartridge safely. Remember that anytime there's a shell in the chamber, your gun is loaded and ready to use. Even if you tried to shoot and your gun didn't fire, treat your firearm as if it could still discharge.

## 7th COMMANDMENT

### **Always Wear Eye and Ear Protection When Shooting.**

*Your sight and hearing* risk injury from shooting and should be protected at all times. Wear protective shooting glasses to guard against falling shot, clay target chips, powder residue, ruptured cartridge cases and even twigs and branches in the field. Also be sure to wear eye protection when you're disassembling or cleaning a gun so that tensioned parts (like springs) and cleaning solvents don't come in contact with your eyes. Continued exposure to shooting noise can permanently damage your hearing. On the range, where shooting volume is the loudest, be sure to use the maximum protection of a headset. And learn to use ear protection in the field, especially in confined locations like duck blinds.



## 8th COMMANDMENT

### **Be Sure the Barrel is Clear of Obstructions Before Shooting.**

*Before loading your gun*, open the action and make sure there's no ammunition in the chamber or magazine. Check the barrel for any obstructions or debris. Even a small amount of snow, mud, excess lubricant or grease in the bore can dangerously increase pressure and cause the barrel to bulge or burst when firing. Use a cleaning rod and patch to wipe away anti-rust compounds or any other residues or obstructions in the barrel. Never try to shoot out an obstruction by loading another shell and firing!

*When firing*, rely on your instincts. If the noise or recoil of your firearm seems weak, stop everything, unload your firearm and be sure nothing is lodged in the barrel. Remember the 12/20 burst? That's what can happen when the barrel is obstructed. So always be sure you're using the correct ammunition in your firearm and that it's free of obstructions.

## 9th COMMANDMENT

### **Don't Alter or Modify Your Gun and Have it Serviced Regularly.**

*Your firearm* has been designed to operate according to certain factory specifications. You'll jeopardize your safety and that of others around you by attempting to alter its trigger, mechanical safety or other mechanisms. So never alter or modify your firearm in any way.

*Like any mechanical device*, a firearm is subject to wear. It must be maintained and periodically serviced to assure optimum safety and performance. Only a qualified service facility should service, repair or modify your Remington® firearm. Consult your instruction book for instructions on how to send your firearm to the factory or for the location of the nearest Remington repair station.

*Proper cleaning and lubrication* are also important to firearm maintenance and are necessary to assure accuracy, safety and reliability. Before cleaning, always make sure that your gun is completely unloaded. And always clean the barrel from the chamber end to the muzzle when possible.



*Make it a practice* to clean your bore every time you're going to shoot. Be sure to clean your entire gun before and after long-term storage and no less than once a year. It's also important to clean your gun whenever it's been exposed to adverse conditions such as rain, dirt, mud, snow, sleet or saltwater.

*For safe and dependable* operation of your firearm, all parts of your gun must be properly cleaned and lubricated. Periodically inspect the internal workings of your firearm to be sure they're clean and free of rust, unwanted dirt and debris.

*Use recommended lubricants* on your gun and do not over-lubricate. Excessive use of a non-recommended lubricant could adversely affect the function and safe operation of your firearm. Remember, you are responsible for the proper care and maintenance of your firearm. Failure to properly maintain your firearm can not only damage or ruin your firearm, it can expose you and others to unnecessary risks of personal injury or death.

*Remington® has a wide range* of firearm care products and resources for best results when cleaning your gun. Everything from solvents and lubricants to rods and patches. They're all available from your Remington dealer.

## 10th COMMANDMENT

### Learn the Mechanics and Handling Characteristics of Your Firearm.

*Not all guns are alike.* They have different mechanical characteristics that dictate how you should carry and handle them. Anyone who plans to use a firearm should first become totally familiar with the type of firearm it is and the safe handling procedures for loading, unloading, carrying, shooting and storing it.

*Before you even unpack* your new Remington firearm, read this instruction book from cover to cover and familiarize yourself with the different component parts of the gun. Then read, understand and follow the Ten Commandments of Firearm Safety in this book.

**WARNING!** Discharging firearms in poorly ventilated areas, cleaning firearms or handling ammunition may result in exposure to lead, a substance known to cause birth defects, reproductive harm, cancer and other serious physical injury. Have adequate ventilation at all times. Wash hands thoroughly after exposure.



### SHOOT SOBER!!

*There's one other rule* that must be followed when handling firearms. In fact, respect for this rule is necessary in order to effectively practice the Ten Commandments of Firearm Safety. The rule is: SHOOT SOBER! Guns and alcohol or drugs make a deadly combination. Never consume anything that would mildly impair your judgment or physical coordination when you're using a firearm. A staggering percentage of the shooting accidents that occur every year involve alcohol or drugs. Be smart. Always shoot sober and stay alive.

**WARNING!** Failure to follow any of these safety rules may cause personal injury or death to the shooter or bystander and damage to property. Do not use a firearm until you fully understand and practice the Ten Commandments of Firearm Safety. If you have any questions about the safe use of a Remington firearm, write to us at Remington Arms Company, Inc., Consumer Service, P.O. Box 700, Madison, NC 27025-0700, or call us at 1-800-243-9700.

### DON'T KEEP THIS TO YOURSELF.

*Now that you're a gun owner* you have the obligation to help ensure that shooting sports are safe for everyone – participants and bystanders alike. You can do that by practicing these principles of firearm safety and passing them on to others – especially new shooters. Set an example for beginners. Be a guide to their safe entry into the exciting world of shooting sports. Invest your time and patience for the love of the sport and for its future. After all, it's your love of the sport that led you to buy a new Remington.

*Firearm ownership* is a right and privilege. It's a right guaranteed in this nation's Constitution. It's a privilege which carries with it a personal responsibility to use your firearm in a way which will ensure your safety and the safety of others. The preservation of this right and privilege depends on the personal commitment of you and your fellow shooters to the safe and responsible use of firearms. Let the Ten Commandments of Firearm Safety outlined in this book guide you at all times. Teach and promote these rules whenever you can. Remember, firearm safety depends on you! That's the only way to really enjoy your new Remington firearm and to preserve sport shooting as we know it today.

# Remington® Model 870™ Pump Action Shotgun

*Congratulations on your choice of a Remington®. With proper care, it should give you many years of dependable use and enjoyment. For best results, we recommend that you use Remington Ammunition – the ammunition used in factory testing your firearm against our exacting function and performance standards.*

**PICTURE A** This picture shows the main parts of a REMINGTON MODEL 870™ PUMP ACTION SHOTGUN. The picture will aid in understanding the instructions in this book.

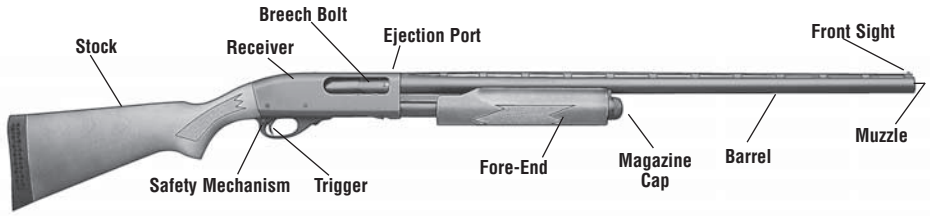

**PICTURE B** This picture shows the parts of the ammunition.

## SHOTGUN SHELL

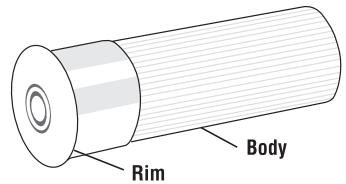

## Important Parts of the Firearm

### The Safety Mechanism

*The safety mechanism on the Model 870™ Pump Action Shotgun is a button located behind the trigger, commonly known as a cross-bolt safety. See Picture 1.*

*The safety mechanism provides protection against accidental or unintentional discharge under normal usage when properly engaged and in good working order.*

*To engage the safety mechanism, push the button so the **RED BAND MARKING CANNOT BE SEEN.***

*Always engage the safety mechanism when the firearm is loaded and you do not intend to shoot.*

*Never pull the trigger when the safety mechanism is engaged.*

*When you are ready to fire the firearm, press the safety mechanism so that the **RED BAND MARKING IS SHOWING.***

*Do not touch the trigger while moving the safety mechanism. Your fingers and all other objects should be kept outside of the trigger guard and away from the trigger until you are actually ready to fire by pulling the trigger.*

**WARNING!** The firearm will fire when the trigger is pulled and the **RED BAND MARKING IS SHOWING.**

Even when the safety mechanism is engaged, careless handling can cause the firearm to fire. See *Ten Commandments of Firearm Safety* on page 2.

### The Security System

*The firearm you have purchased is equipped with an integrated security system. The security system enables the owner to lock the safety mechanism on the firearm in the **"SAFE"** position with the use of a special key.*

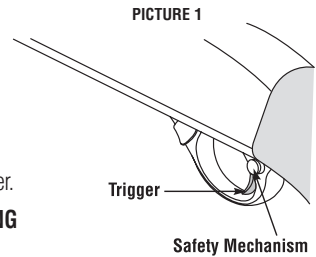

**THIS SECURITY SYSTEM DOES NOT ELIMINATE THE NEED FOR SAFE GUN HANDLING AND STORAGE, INCLUDING KEEPING THIS AND EVERY GUN UNLOADED AND LOCKED IN A SECURE PLACE WHEN NOT IN USE. READ AND FOLLOW THESE AND OTHER SAFETY RULES IN THIS INSTRUCTION BOOK. FAILURE TO READ, UNDERSTAND AND OBEY THESE RULES CAN RESULT IN SERIOUS PERSONAL INJURY OR DEATH TO YOU OR OTHERS. SEE THE TEN COMMANDMENTS OF FIREARM SAFETY ON PAGE 2.**

The safety mechanism on the firearm you have purchased is a button located behind the trigger, commonly known as the cross-bolt safety. See Picture 1 on page 7.

The safety mechanism provides additional protection against accidental or unintentional discharge under normal usage when properly engaged and in good working order.

On the safety mechanism there is a “J” shaped slot. See Picture 2. This “J” slot is the key hole for securing your safety mechanism. Also on the safety mechanism is a pointer which will point and line up with either the **RED** or **WHITE DOT** on the trigger plate when the safety mechanism is turned. See Picture 2. The position of the pointer indicates whether or not the security system is engaged. The existence of the security system does not change the basic operation of the safety mechanism, nor does it change the manner in which the safety mechanism should be used.

With your new firearm you will receive a capped key. To use the key remove the cap. On the key is an indicator line which will line up with the pointer on the safety mechanism. See Picture 3.

To engage the security system, press the safety mechanism to the “**SAFE**” position so the **RED BAND DOES NOT SHOW**. Insert the key into the “**J**” slot as far as it can go. Next, turn the key counter-clockwise so that the indicator line on the key and the pointer on the safety mechanism line up with the **WHITE DOT** on the trigger plate.

**THE SECURITY SYSTEM IS NOW ENGAGED.**

In operating the security system, **NEVER** use excessive force to turn the key. If the key will not turn freely, contact a Remington® authorized repair center.

Keep your security system engaged and your safety mechanism in the “**SAFE**” position when your firearm is not in use. Keep your key in a secure place, inaccessible to others. **DO NOT** leave your key or any ammunition with your firearm, which should be kept unloaded and locked in a safe place.

If you lose the key, **DO NOT** attempt to disengage the safety mechanism using a foreign object. This will damage your firearm. Contact your Remington authorized dealer for a replacement key.

Even if you think the security system and safety mechanism are engaged, careless handling can cause the firearm to fire. See the *Ten Commandments of Firearm Safety* on page 2.

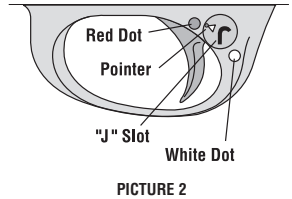

PICTURE 2

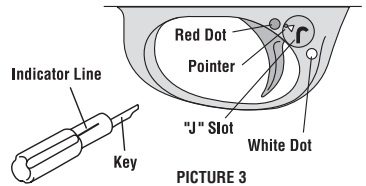

PICTURE 3

## The Fore-End

The fore-end is used to pull the bolt rearward to open the action.

### TO OPEN THE ACTION:

1. Push upward on the action bar lock. See Picture 4.
2. Pull the fore-end rearward to open the action.

**WARNING!** When the fore-end is forward, the action is closed and the firearm can be fired.

## The Trigger

Pulling the trigger fires the firearm.

The weight of the trigger pull is preset at the factory. All adjustments to the trigger and trigger plate assembly must be made by the factory or a REMINGTON RECOMMENDED GUNSMITH.

**WARNING! NEVER** put your finger on the trigger unless you are going to fire the firearm.

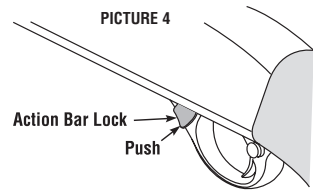

PICTURE 4



**BARREL INTERCHANGEABILITY:**

**NOTE:** All Model 870™ 12-gauge barrels are interchangeable without adjustment, except the Model 870 12-gauge Super Magnum™ and Model 870 12-gauge Special Field.

**WARNING! BEFORE LOADING, ALWAYS CHECK THE BARREL MARKING FOR THE CORRECT GAUGE AND CHAMBER LENGTH. NEVER USE AMMUNITION WHICH EXCEEDS THE CHAMBER LENGTH SHOWN ON THE BARREL.**

## The Barrel

*The inside of the barrel must be clean and free of obstructions.*

**I. TO CHECK THE INSIDE THE BARREL:**

**WARNING!** Look into the ejection port. Check the chamber and magazine to make sure there are no shells in the firearm.

1. Point the firearm in a safe direction.
2. Engage the safety mechanism. Make sure the **RED BAND IS NOT SHOWING**.
3. Pull the fore-end fully rearward to open the action.
4. Insert a cleaning rod into the muzzle. Push the cleaning rod all the way through the barrel, until the rod can be seen in the ejection port.

**II. TO REMOVE AN OBJECT FROM INSIDE THE BARREL:**

**WARNING! NEVER** try to remove an object from the barrel by loading a cartridge and firing. This may cause the barrel to burst or a cartridge case to rupture and cause serious personal injury or serious damage to the firearm and injury or death to the shooter or bystanders.

1. Remove the barrel following the instructions on page 13.
2. Use the correct cleaning rod.
3. Insert a cleaning rod into the muzzle and lightly tap rod to free objects.
4. If an object cannot be easily pushed out of the barrel with a cleaning rod, return the firearm to the factory or a REMINGTON® RECOMMENDED GUNSMITH.

**III. TO CLEAN THE BARREL AND CHOKE TUBE FOLLOW THE INSTRUCTIONS SHOWN ON PAGE 13:**

**BEFORE LOADING THE FIREARM:**

Make sure the inside of the barrel is free of dirt or other objects.

**TO CHANGE THE CHOKE TUBE:**

**WARNING! UNLOAD** the firearm before changing choke tubes. Leave the action **OPEN** and the chamber and magazine **EMPTY**.

1. Point the firearm in a safe direction.
2. Engage the safety mechanism. Make sure the **RED BAND IS NOT SHOWING**.
3. Place the choke tube wrench into the choke tube.
4. Turn the wrench counter-clockwise and remove the choke tube.
5. Select the desired choke tube and insert the tube into the barrel.
6. Tighten the choke tube snugly, but **DO NOT OVERTIGHTEN**.
7. With the action open and the chamber and magazine empty, check the choke tube occasionally to make sure the tube has not loosened.

**NOTE: NEVER** fire the firearm without the choke tube installed.

## How To Assemble

The Model 870™ Pump Action Shotgun is shipped with the barrel assembly removed. See Picture 5 for location of parts.

**WARNING! DO NOT** pump the action or pull the trigger repeatedly with the barrel removed.

1. Before assembling, clean the barrel following instructions on page 13.
2. Unscrew and remove the magazine cap.
3. Remove the cardboard packing ring from the magazine tube. See Picture 5.
4. Press upward on the action bar lock. See Picture 4. Pull the fore-end approximately halfway rearward.
5. Hold the barrel ahead of the barrel guide ring. See Picture 6.
6. Slide the barrel guide ring over the magazine tube.
7. Align the ejector cut on the rear of the barrel with the ejector in the receiver. See Picture 7.
8. Carefully seat the barrel into the receiver. DO NOT force the barrel against the ejector.
9. Replace and tighten the magazine cap.

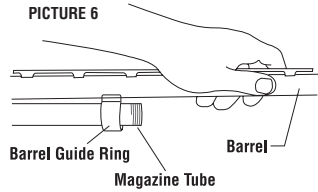
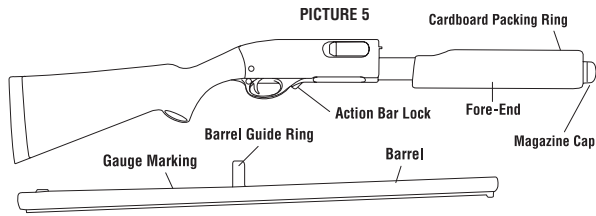

## How To Load And Unload

**WARNING!** Always check the shell for the correct gauge and length before loading the firearm.

### I. TO LOAD ONE SHELL ONLY:

1. Point the firearm in a safe direction.
2. Engage the safety mechanism. **RED BAND WILL NOT SHOW.**
3. Push upward on the action bar lock.
4. Pull the fore-end fully rearward to open the action.
5. Put one shell of the correct gauge and length through the ejection port. See Picture 8.
6. Push the fore-end forward to close the action.

**WARNING! THE FIREARM IS NOW LOADED AND CAN BE FIRED.**

7. To fire the firearm, first disengage the safety mechanism. **RED BAND WILL SHOW.**

**THE FIREARM IS READY TO FIRE.**

8. Pull the trigger to fire the firearm.
9. Pull the fore-end fully rearward forcefully to eject the empty shell.

**WARNING!** Always check the shell for the correct gauge and length before loading the firearm.

### II. TO LOAD THE CHAMBER AND MAGAZINE:

1. Point the firearm in a safe direction.
2. Engage the safety mechanism. **RED BAND WILL NOT SHOW.**
3. Push upward on the action bar lock.
4. Pull the fore-end fully rearward to open the action.
5. Put one shell of the correct gauge and length through the ejection port. See Picture 8.
6. Push the fore-end forward to close the action.

**THE FIREARM IS NOW LOADED.**

7. Press shell against the carrier. See Picture 9.
8. Push three (3) 3-1/2" (870 Super Magnum™ only) shells or four (4) 3" or 2-3/4" shells of the correct gauge and length, one at a time, fully forward into the magazine.

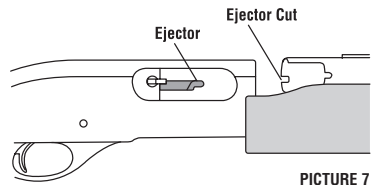

PICTURE 7

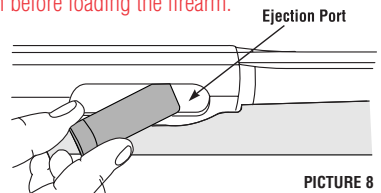

PICTURE 8

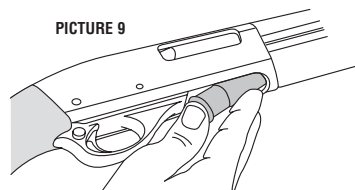

**WARNING! BEFORE LOADING, ALWAYS CHECK THE BARREL MARKING FOR THE CORRECT GAUGE AND CHAMBER LENGTH. NEVER USE AMMUNITION WHICH EXCEEDS THE CHAMBER LENGTH SHOWN ON THE BARREL.**

**WARNING!** Be sure the rim of each shell snaps past the shell latch to prevent the shell from sliding back over the carrier.

If the shell slides back over the carrier:

- Engage the safety mechanism. Make sure the **RED BAND IS NOT SHOWING**.
- Keep the firearm pointed in a safe direction.
- Forcefully **OPEN** the action or
- **REMOVE** the trigger plate assembly following the instructions shown on page 13 and remove the shell.

**THE CHAMBER AND MAGAZINE ARE NOW FULLY LOADED.**

9. To fire the firearm, first disengage the safety mechanism. **RED BAND WILL SHOW.**

**THE FIREARM IS READY TO FIRE.**

10. Pull the trigger to fire the firearm.
11. Pull the fore-end fully rearward forcefully to eject the empty shell.
12. Slide the fore-end forward to chamber the next shell.
13. Engage the safety mechanism when you are finished firing. **RED BAND WILL NOT SHOW.**

### **III. TO UNLOAD THE FIREARM:**

1. Point the firearm in a safe direction.
2. Engage the safety mechanism. **RED BAND WILL NOT SHOW.**
3. Push upward on the action bar lock.
4. Pull the fore-end slowly rearward until the front of the shell is even with the ejection port.
5. Lift the front of the shell outward and remove from the ejection port.
6. Pull the fore-end fully rearward until the next shell is released from the magazine.
7. Tip the firearm sideways to allow the shell to drop from the ejection port.
8. Close and open the action until all shells are removed.

**WARNING!** Look into the ejection port. Check the chamber and magazine to make sure there are no shells in the firearm.

## **To Assemble The Magazine Plug**

**WARNING!** A magazine plug which limits the magazine capacity to two (2) shells must be installed according to The Federal Migratory Bird Treaty Act and some state laws.

**NOTE:** There are two types of magazine spring retainers used in the Model 870™ shotgun. One has a round hole in the center, the other has a slot in the center.

### **TO INSTALL THE MAGAZINE PLUG ON FIREARMS HAVING MAGAZINE SPRING RETAINERS WITH A HOLE IN THE MAGAZINE SPRING RETAINER:**

1. Engage the safety mechanism. **RED BAND WILL NOT SHOW.**
2. Check the chamber and the magazine to make sure there are no shells in the firearm.
3. Unscrew and remove the magazine cap.
4. Put a screwdriver into the open end of the magazine tube. Move the tip under the rim of the magazine spring retainer. See Picture 10.
5. Place your hand over the end of the magazine tube.
6. Using the screw driver, pry up and remove the magazine spring retainer.

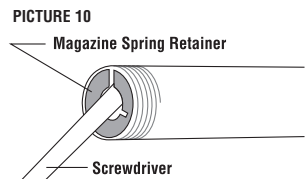

**WARNING!** Always wear eye protection and use extreme care when removing the magazine spring retainer, as the retainer is under tension from the magazine spring.

7. Place the small end of the magazine plug into the magazine spring. See Picture 11.
8. Put the magazine spring retainer over the large end of the magazine plug.
9. Push the magazine spring, magazine plug and the magazine retainer into the magazine tube.
10. Tap the magazine spring retainer into the magazine tube, even to the end of the magazine tube.
11. Replace and tighten the magazine cap.

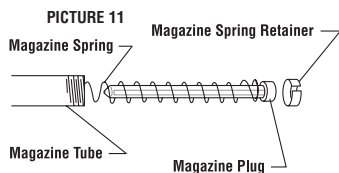

## TO INSTALL THE MAGAZINE PLUG ON FIREARMS HAVING MAGAZINE SPRING RETAINERS WITH A SLOT IN THE MAGAZINE SPRING RETAINER:

1. Engage the safety mechanism. **RED BAND WILL NOT SHOW.**
2. Check the chamber and the magazine to make sure there are no shells in the firearm.
3. Unscrew and remove the magazine cap.
4. Put a screwdriver into the slot in the magazine spring retainer. See Picture 12.
5. Place your hand over the end of the magazine tube.
6. Push the magazine spring retainer into the magazine tube.
7. Turn the retainer 90° and slowly release the retainer. See Picture 12.

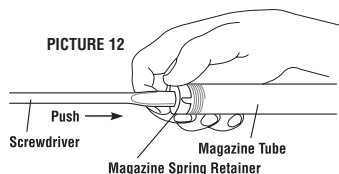

**WARNING!** Always wear eye protection and use extreme care when removing the magazine spring retainer, as the retainer is under tension from the magazine spring.

8. Place the small end of the magazine plug into the magazine spring. See Picture 13.
9. Work the magazine spring into the magazine tube.
10. Put the open end of the magazine spring retainer over the large end of the magazine plug.
11. Align the detent slot on the magazine spring retainer with the detents on the top and bottom of the magazine tube.
12. Push the magazine spring, plug and retainer into the magazine tube approximately one (1) inch.
13. Turn the retainer 90° to lock the retainer into position.
14. Slowly release the retainer to make sure that the retainer is properly seated.
15. Replace and tighten the magazine cap.

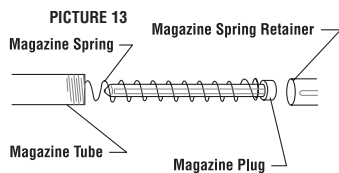

## How To Disassemble

1. Engage the safety mechanism. **RED BAND WILL NOT SHOW.**
2. Push the action bar lock upward and pull the fore-end rearward to open the action.

**WARNING!** Look into the ejection port and check the chamber and magazine to make sure there are no shells in the firearm.

3. Slide the fore-end forward approximately halfway.
4. Unscrew and remove the magazine cap.
5. Take hold of the barrel ahead of the magazine tube and pull the barrel from the receiver.
6. Push the carrier upward.
7. Reach into the bottom of the receiver. Depress and hold the left shell latch. See Picture 14.
8. Slide the fore-end forward and off of the magazine tube.

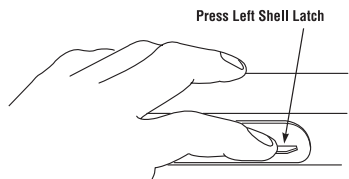

PICTURE 14

**NOTE:** The top right edge of the slide may bind on the bottom front edge of the ejection port in the receiver. To free the slide, push the front end of the bolt down. See Picture 15.

9. Lift the breech bolt assembly and slide assembly from the rear of the action bars.

**NOTE:** Steps 10-12 are for the Model 870™ Super Magnum™ ONLY.

10. Turn breech bolt assembly upside down. (Refer to **NOTE** after step 8.)
11. Place a small thin-bladed screwdriver under tab of port cover and lift slightly. See Picture 16.
12. Slide port cover rearward from the breech bolt assembly.
13. Tap out the front and rear trigger plate pins. See Picture 15.
14. Lift the rear of the trigger plate assembly, slide rearward and remove from the receiver.

**WARNING! DO NOT** allow the hammer to snap forward when the trigger plate is removed. This can best be assured by keeping the safety mechanism engaged at all times. **RED BAND WILL NOT SHOW.**

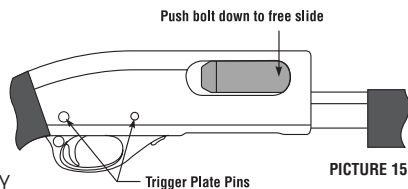

PICTURE 15

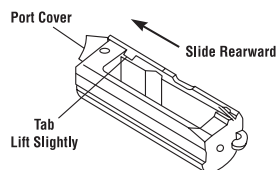

**NOTE: PORT COVER USED ON MODEL 870™ SUPER MAGNUM™ ONLY.**

PICTURE 16

## Lubrication And Maintenance

**WARNING!** Look into the ejection port and check the chamber and magazine to make sure there are no shells in the firearm before cleaning or storing.

### TO CLEAN THE BARREL:

1. Use the instructions and the equipment provided in a good shotgun cleaning kit. For recommendations, see your Remington® Authorized Gunsmith or dealer.
2. Select the correct gauge cleaning brush and attach the brush to the cleaning rod.
3. Put the cleaning brush into gun cleaning solvent.
4. Push the cleaning rod through the barrel several times.
5. Push the correct size cleaning patch through the bore.
6. Repeat several times using a clean patch each time until the patch is not dirty.
7. Remove all shooting residue from the locking notch in the barrel. See Picture 17.

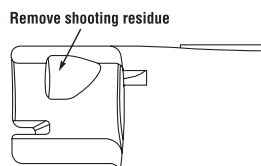

PICTURE 17

### TO CLEAN THE CHOKE TUBE:

1. Remove the choke tube from the barrel.
2. Clean the choke tube including the threads with gun cleaning solvent and wipe dry.
3. Apply Rem™ Oil on threads and reassemble the choke tube to the barrel following the instructions on page 10.

**WARNING!** After cleaning, make sure the barrel is free of obstructions.

### THE BREECH BOLT ASSEMBLY:

Clean as a unit. Brush with cleaning solvent and wipe clean and dry.

### THE RECEIVER:

Brush the inside of the receiver with cleaning solvent and wipe dry.

**WARNING!** There may be sharp edges inside the receiver. Keep fingers covered or gloved when wiping.

### THE TRIGGER PLATE ASSEMBLY:

**NOTE:** Clean as a unit with Rem™ Oil only. See **NOTE** at the bottom of page 14.

Spray the trigger plate assembly with Rem™ Oil as shown. See Picture 18. Let stand for 15 minutes. Spray again to wash off components. Shake off excess lubricant.

**WARNING!** Excessive use of a non-recommended lubricant could adversely affect the function and safe operation of your firearm.

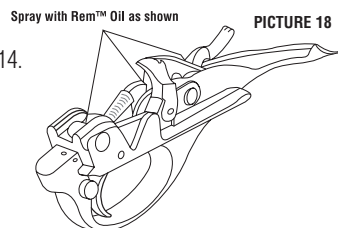

## How To Reassemble

1. Check to make sure that the end of the action bar lock is below the end of the left connector. See Picture 19.
2. Carefully insert the trigger plate assembly (carrier first) into the receiver.
3. Position to align the holes and tap in front and rear trigger plate pins.
4. Place the fore-end assembly over the magazine tube.

**NOTE:** Steps 5 & 6 are for Model 870™ Super Magnum™ only.

5. Slide port cover spring into position in the bottom of the bolt.
6. Align the port cover and slide forward until the port cover snaps into position.
7. Position the slide block assembly and breech bolt assembly on the rear of the action bars. See Picture 20.
8. Guide the action bars into the receiver until stopped by the right shell latch.
9. Push the carrier upward, depress and hold the right shell latch. See Picture 21.
10. Slide the fore-end rearward until stopped by the left shell latch.
11. Reach into the bottom of the receiver. Depress and hold the left shell latch. See Picture 22.
12. Slide the fore-end rearward until stopped by the action bar lock.
13. Push upward on the action bar lock. Slide the fore-end rearward approximately halfway.
14. Replace the barrel and magazine cap.

**WARNING!** This firearm should be checked periodically by the Remington® Arms Company, Inc. or a REMINGTON RECOMMENDED GUNSMITH. This will ensure proper inspection and any necessary replacement of worn or damaged parts.

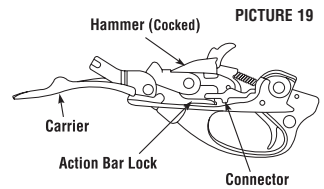

PICTURE 19

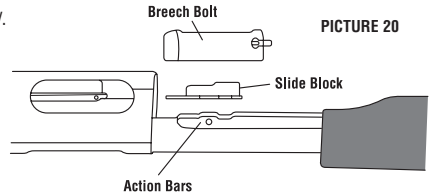

PICTURE 20

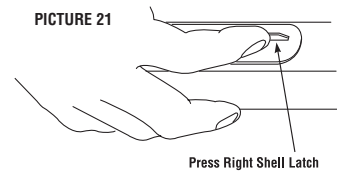

PICTURE 21

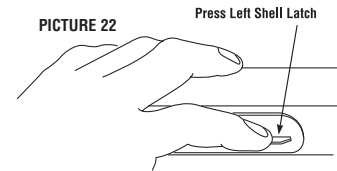

PICTURE 22

## Lubrication

*Over-lubrication should be avoided at all times. A thin coat of Rem™ Oil is all that is needed to prevent the possibility of rusting. See NOTE below.*



*When the firearm is to be stored, it should be carefully cleaned and thoroughly oiled. Outside surfaces should be wiped with a light coat of Rem™ Oil occasionally. See NOTE below.*

*When the firearm is to be reused, all excess lubrication must be removed. The chamber and bore must be thoroughly wiped dry.*

**NOTE:** Remington Rem™ Oil is available from your local dealer. If your dealer is out of stock, ask him to order Rem™ Oil from their Remington distributor.

# How to Obtain Parts and Service From Remington.®

## TO ORDER PARTS:

Many Remington® Dealers and Authorized Repair Centers carry a full line of parts. Please check with them first before ordering parts.

To expedite your PARTS order or request REPAIR SERVICE visit our web site at [www.remington.com](http://www.remington.com). Detailed instructions are provided along with parts and/or service order forms. You may also reach Remington by calling our toll free customer service number, 1-800-243-9700, Mon.-Fri., 9:00 AM-5:00 PM Eastern time.

1. Fax completed order form (from the web site) to 1-336-548-7801.
2. To order by phone without the order form call 1-800-243-9700.

## Please have the following information ready before you call.

- Firearm model and serial number.
- Part description and quantity. Part descriptions can be found on the parts listing page in this manual.
- Your complete mailing address (P.O. Box and Street Address) including zip code, telephone number and e-mail address.
- Method of payment: Mastercard, Visa, Amex or Discover card number and expiration date. Prepayment may be made by check or money order. A quote may be made to you over the phone. (Sorry, no C.O.D.s.)

## WARNING! USE ONLY REMINGTON PARTS IN REMINGTON FIREARMS.

**NOTE:** SOME PARTS MAY BE RESTRICTED. See parts list for details. Owner's manuals/instruction books may be requested via our web site at: [www.remington.com](http://www.remington.com) or by calling 1-800-243-9700.

## REPAIR SERVICES

1. To locate the Remington Authorized Repair Center nearest you visit our web site at [www.remington.com](http://www.remington.com) and use our Repair Service Locator. If you need additional on-line assistance, e-mail us at [info@remington.com](mailto:info@remington.com) to obtain a listing of Authorized Repair Centers. Contact the Authorized Repair Center of your choice for evaluation of your firearm and/or additional shipping instructions.
2. If your Remington Authorized Repair Center cannot provide the service or repair you require and you need further assistance, please call our toll free number 1-800-243-9700, Mon.-Fri., 9:00 AM-5:00 PM Eastern time and select the option for repairs. Then, if shipment of your firearm is required, please:
  - Record the serial number of your firearm before sending it to us.
  - Pack your firearm for safety and to prevent further damage in shipping and handling. Preferably, ship in a firearm box.
  - Remove all accessories from the firearm to prevent loss or damage.
  - Enclose a letter with the firearm detailing the model name or number of your firearm and serial number along with a full description of the problem. Be sure to include your full name and address (P.O. Box and Street Address), including zip code, daytime telephone number and e-mail address.
  - Ship your firearm by either United Parcel Service (UPS) or Parcel Post (US Post Office). Remington is not responsible for damage or loss during shipment, so you may elect to purchase insurance from your carrier.

### Ship to:

Remington Arms Company, Inc.  
Attn: Arms Service Division/Repairs  
14 Hoefler Ave.  
Ilion, NY 13357

**WARNING! DO NOT SEND LIVE OR SPENT SHELLS IN YOUR FIREARM OR IN THE SAME BOX WITH THE FIREARM. THIS IS A VIOLATION OF FEDERAL LAW. IF YOU FEEL YOU MUST SEND SPENT SHELLS, PLEASE SEND THEM IN A SEPARATE PACKAGE AND INCLUDE NAME, ADDRESS (WITH ZIP CODE), TELEPHONE NUMBER, MODEL AND SERIAL NUMBER OF YOUR FIREARM.**

# MODEL 870™

## Pump Action Shotgun

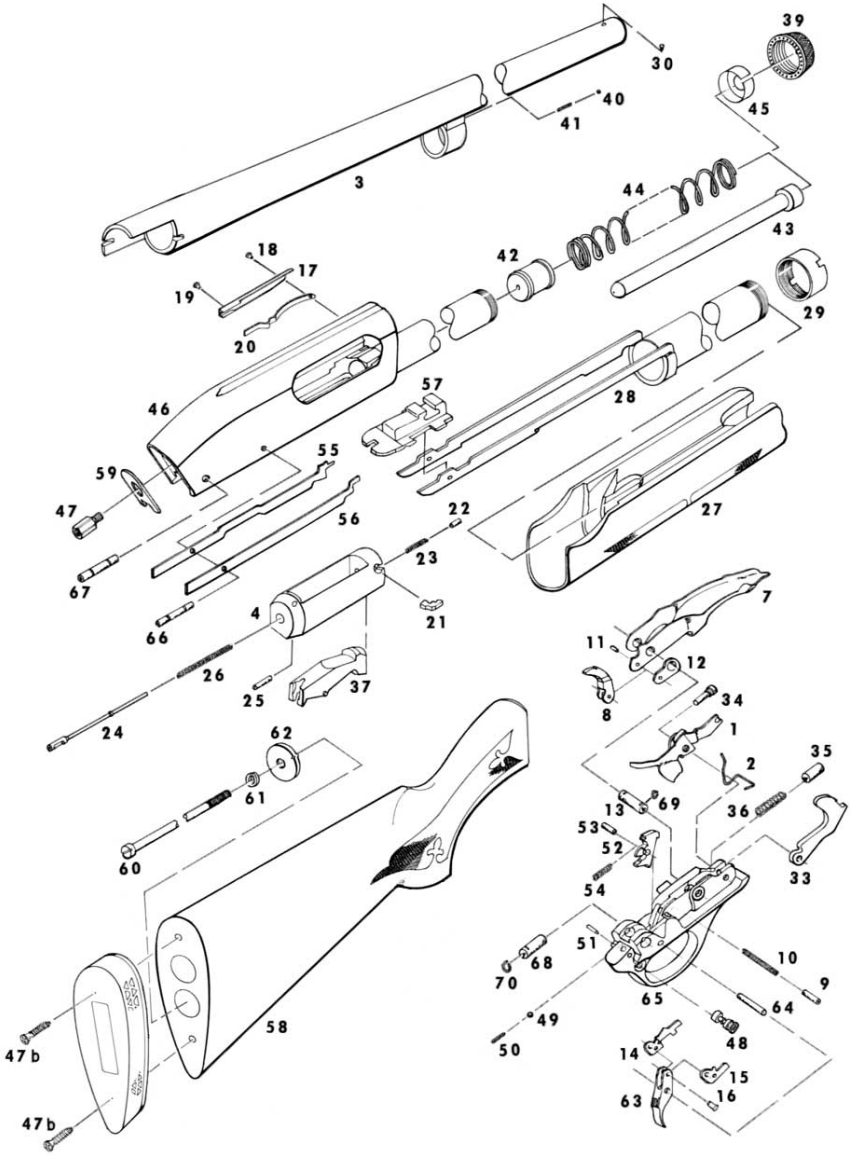



# MODEL 870™

## Pump Action Shotgun

### PARTS LIST

---

**VIEW # PART NAME**

**NOTE:** 12 Ga. Express Listed Below

- 1 Action Bar Lock
- 2 Action Bar Lock Spring

**NOTE:** All barrels (same gauge) are interchangeable without adjustment.

- 3 Barrel Assembly
- 4 Breech Bolt
- Breech Bolt Assembly
- 7 Carrier
- Carrier Assembly
- 8 Carrier Dog
- 9 Carrier Dog Follower
- 10 Carrier Dog Follower Spring
- 11 Carrier Dog Pin
- 12 Carrier Dog Washer
- 13 Carrier Pivot Tube
- 14 Connector, Left
- 15 Connector, Right
- 16 Connector Pin
- 17 Ejector
- 18 Ejector Rivet, Front
- 19 Ejector Rivet, Rear
- 20 Ejector Spring
- 21 Extractor
- 22 Extractor Plunger
- 23 Extractor Spring
- 24 Firing Pin
- 25 Firing Pin Retaining Pin
- 26 Firing Pin Retractor Spring
- Fore-end (Wood Only)
- 27 Fore-end Assembly
- 28 Fore-end Tube Assembly
- 29 Fore-end Tube Nut
- 30 Front Sight
- 33 Hammer
- 34 Hammer Pin
- Hammer Pin Washer
- 35 Hammer Plunger
- 36 Hammer Spring

**VIEW # PART NAME**

- 37 Locking Block Assembly
- Locking Block Assembly (Oversize)
- Locking Block Retainer
- 39 Magazine Cap
- 40 Magazine Cap Detent
- 41 Magazine Cap Detent Spring
- 42 Magazine Follower
- 43 Magazine Plug, 3-Shot
- 44 Magazine Spring
- 45 Magazine Spring Retainer
- 46 Receiver Assembly (Restricted)
- 47 Receiver Stud
- 47b Recoil Pad Screw
- 48 Safety Mechanism
- 49 Safety Mechanism Detent Ball
- 50 Safety Mechanism Spring
- 51 Safety Mechanism Spring Retaining Pin
- 52 Sear
- 53 Sear Pin
- 54 Sear Spring
- 55 Shell Latch, Left
- 56 Shell Latch, Right
- 57 Slide Assembly
- 58 Stock Assembly
- 59 Stock Bearing Plate
- 60 Stock Bolt
- 61 Stock Bolt Lock Washer
- 62 Stock Bolt Washer
- 63 Trigger Assembly (Restricted)
- 64 Trigger Pin
- 65 Trigger Plate, R.H. Safety Mechanism (Restricted)
- Trigger Plate, L.H. Safety Mechanism (Restricted)
- Trigger Plate Assembly, R.H. Safety Mechanism
- Trigger Plate Assembly, L.H. Safety Mechanism
- 66 Trigger Plate Pin, Front
- 67 Trigger Plate Pin, Rear
- 68 Trigger Plate Pin Bushing
- 69 Trigger Plate Pin Detent Spring, Front
- 70 Trigger Plate Pin Detent Spring, Rear

# Firearm Owner's Record

---

Model \_\_\_\_\_ Serial # \_\_\_\_\_ Date Purchased \_\_\_\_\_

Purchased From \_\_\_\_\_ Price Paid \_\_\_\_\_

Remember to complete and return the Firearm Warranty Registration Card in order to obtain full benefit of your Limited Two Year Firearm Warranty.

## **A WORD ON THE MAINTENANCE AND CARE OF YOUR REMINGTON FIREARM**

### **Don't Alter or Modify Your Gun and Have it Serviced Regularly.**

*Your firearm has been designed to operate according to certain factory specifications. You'll jeopardize your safety and that of others around you by attempting to alter its trigger, mechanical safety or other mechanisms. So never alter or modify your firearm in any way.*

*Like any mechanical device, a firearm is subject to wear. It must be maintained and periodically serviced to assure optimum safety and performance. Only a qualified service facility should service, repair or modify your Remington® firearm. Consult your instruction book for instructions on how to send your firearm to the factory or for the location of the nearest Remington repair station. Remington recommends that you have your firearm professionally serviced annually. You should also have your firearm professionally serviced after prolonged storage, or if there is ever any question pertaining to the proper functioning characteristics of your firearm.*

*Proper cleaning and lubrication are also important to firearm maintenance and are necessary to assure accuracy, safety and reliability. Before cleaning, always make sure that your gun is completely unloaded. And always clean the barrel from the chamber end to the muzzle when possible.*



*Remington*®

REMINGTON IS A TRADEMARK REGISTERED IN THE UNITED STATES PATENT  
AND TRADEMARK OFFICE BY REMINGTON ARMS COMPANY, INC.